



CONTOUR ERGO

OUTFITTING ADJUSTMENT MANUAL

SAFETY

TABLE OF CONTENTS

- 2 IMPORTANT STUFF
- 3 SYSTEM OVERVIEW
- 4 CREEK SEAT OVERVIEW
- 5 PLAY SEAT OVERVIEW
- 6 FOOT BRACE OVERVIEW
- 7 FOOT BRACE OVERVIEW (CONT)
- 8 FREESTYLE FOOT BRACE;
THIGH BRACE OVERVIEW
- 9 HIP PAD OVERVIEW
- 10 LEG LIFTER;
SEAT BOOSTER SHIM OVERVIEW
- 11 BACK BAND OVERVIEW
- 12 STORAGE AND GEAR ATTACHMENT

TOOLS REQUIRED

- 4mm Hex Allen Wrench (Included)
- Standard Phillips Head Screwdriver

READ OWNER'S INFORMATION PACKAGE PRIOR TO USING THIS PRODUCT.

Paddlesports can be very dangerous and physically demanding. The user of this product should understand that participating in paddlesports may involve serious injury or death. Observe the following safety standards when ever using this product.

- Get paddlesports instruction from a licensed or certified instructor.
- Obtain certified first aid and rescue training and carry first aid and rescue equipment.
- Always wear a nationally-approved personal floatation device.
- Always wear a helmet where appropriate.
- Dress appropriately for weather conditions; cold water and/or cold weather can result in hypothermia.
- Check your equipment prior to each use for signs of wear or failure.
- Never paddle alone.
- Do not paddle in flood conditions.
- Be aware of appropriate river water levels, tidal changes, dangerous currents and weather changes.
- Scout unfamiliar waters; portage where appropriate.
- Do not exceed your paddling ability; be honest with yourself.
- Consult your physician prior to beginning your paddlesport training.
- Follow the manufacturer's recommendations for the use of this product.
- If additional outfitting is added to this craft, use manufacturer's approved materials only; do not impair entry or exit access.

Read owner's information package prior to using this product. The user of this product acknowledges both an understanding and an assumption of the risk involved in paddlesports. If you do not have an owner's information package, one may be obtained at no charge by calling 1-888-52-KAYAK (1-888-525-2925).

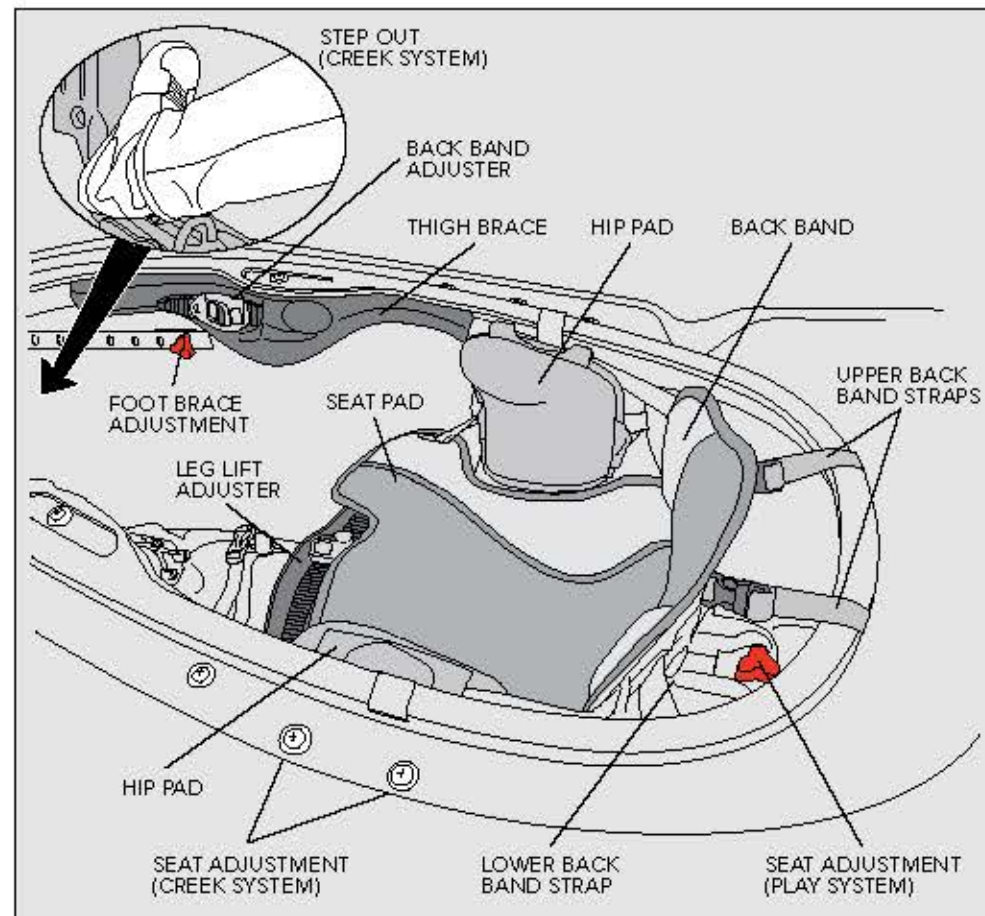

OVERVIEW

- **SEAT ADJUSTMENT**
Allows for comfortable seat positioning (creek or play style seats)
- **FOOT BRACE ADJUSTMENT KNOBS (L/R)**
Allows for comfortable, positive foot position adjustment (see page 8 for freestyle foot brace)
- **THIGH BRACE (L/R)**
Adjusts for comfort against the thighs for increased boat control
- **HIP PADS (L/R)**
Adjust for comfort to prevent excess movement
- **LEG LIFT ADJUSTER**
Adjusts Leg Lifter beneath the thighs for comfortable leg positioning
- **BACK BAND**
Adjustable for comfort and support
- **BACK BAND STRAPS**
Adjustable for fine tuning back band comfort
- **BACK BAND ADJUSTER (L/R)**
Adjusts back band for comfort against the lower back.
- **STEP OUT**
Used for emergency egress of kayak.

PRO TIP - Listed in recommended order of adjustment.

CREEK SEAT ADJUSTMENT

1. Loosen, but **DO NOT** remove, five seat adjustment screws.
2. With both hands, slide the seat assembly fore or aft to the desired location.
3. Tighten five adjustment screws securely.

PRO TIP

- Once loosened the seat adjustment screws may require a good smack from the top to loosen the assembly.
- Safety step outs save lives! In the result of a pin, use the step out wall to assist in exiting the kayak.
- The step out wall has an integrated gripping handle and thumb locator for comfort and control when shouldering your kayak.

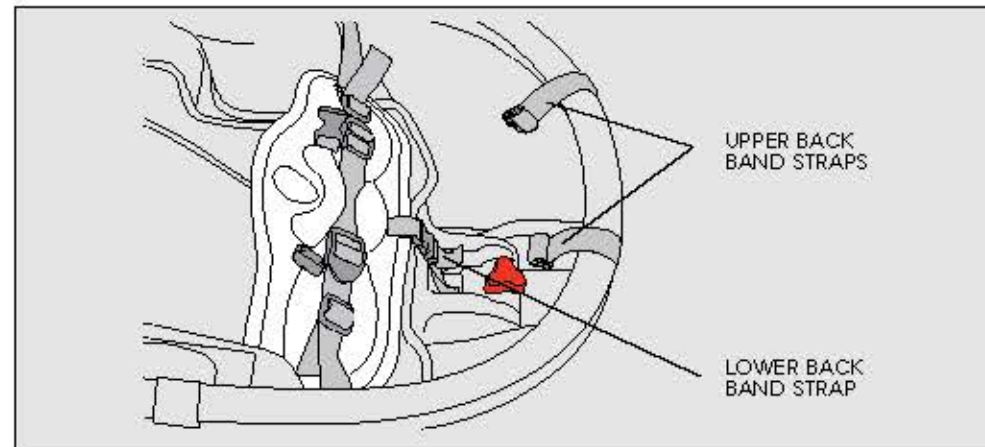
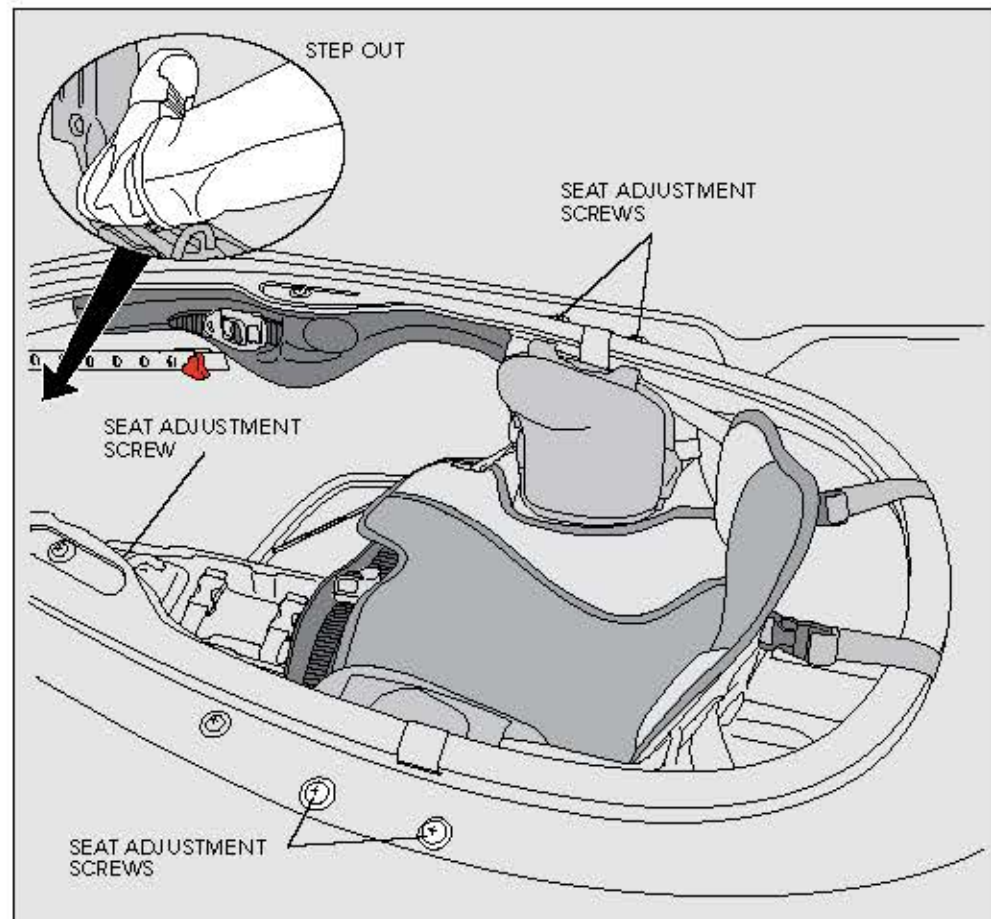

PLAY SEAT ADJUSTMENT

1. Unfasten the upper back band straps.
2. Loosen the seat adjustment knob by turning five to six times but **DO NOT** remove it.
3. With both hands positioned as shown, press straight downward on the rear adjustment knob and slide the seat assembly to the desired location.
4. Tighten the adjustment knob securely.
5. Fasten both upper back band straps.

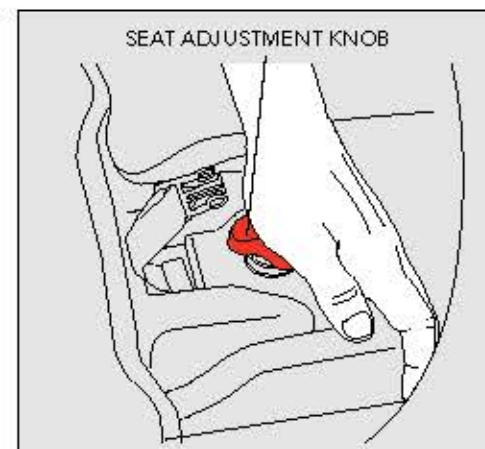
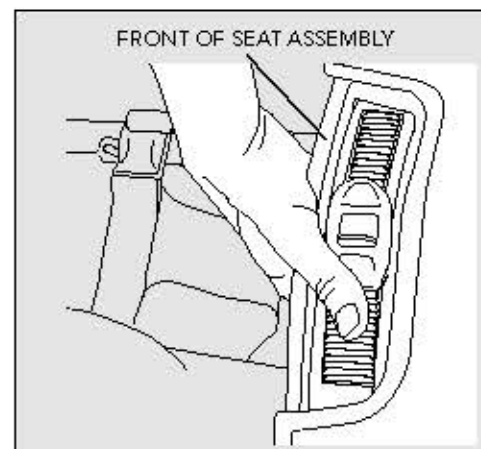

PRO TIP - Always test your adjustments on calm water!

FOOT BRACE ADJUSTMENT

1. Remove both adjustment knobs.
2. Remove both rails from the positioning studs and re-position to the desired location based upon your comfort. Note: Make sure you have outfitted the foot braces with the desired level of foam padding and are wearing preferred paddling gear to attain proper final positioning.
3. Loosen all four foot cup adjustment screws with the 4mm Allen Key (provided).
4. Adjust each foot cup so that its top is flush against the underside of the deck. **IMPORTANT:** Do not leave any space between the top of the foot cup and the underside of the deck where your feet can become entrapped.
5. **Tighten all four foot cup adjustment screws securely.**
6. Fasten both adjustment knobs securely.

PRO TIP - Safety first! Always adjust your spring-loaded plates to eliminate gaps and be sure to **LOCK THEM IN PLACE** by tightening securely.

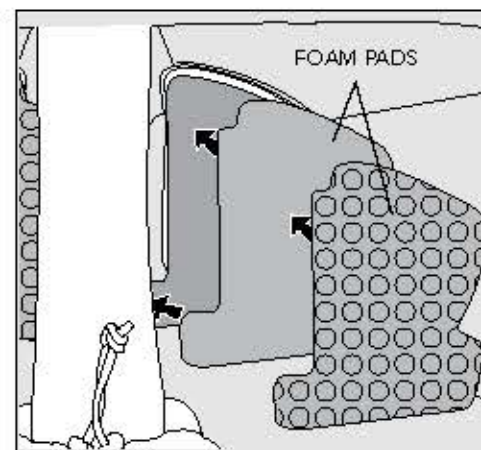
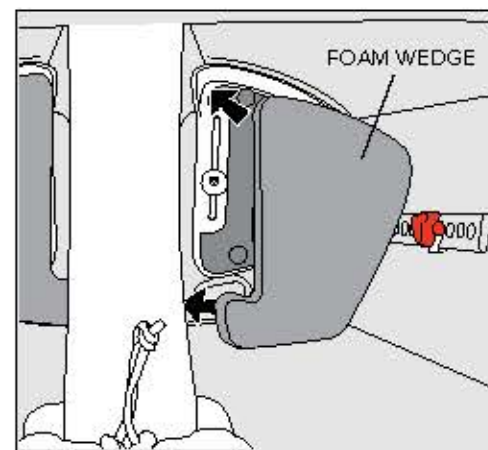
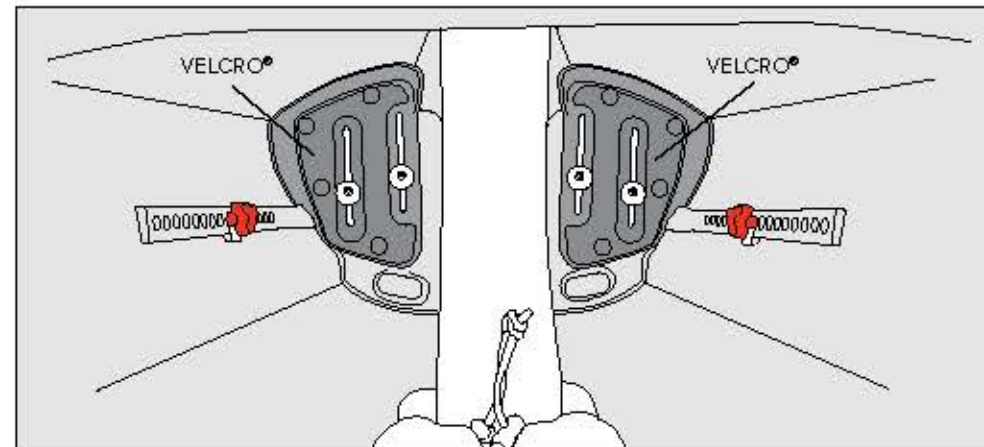
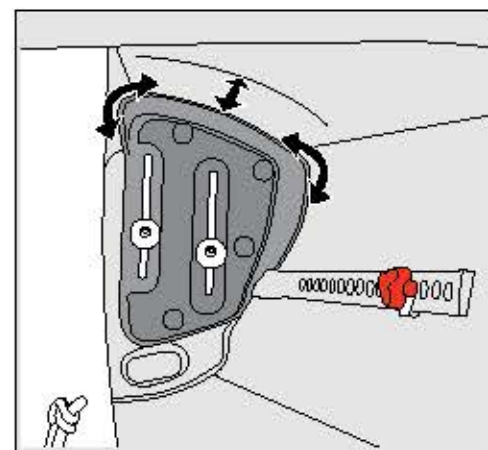
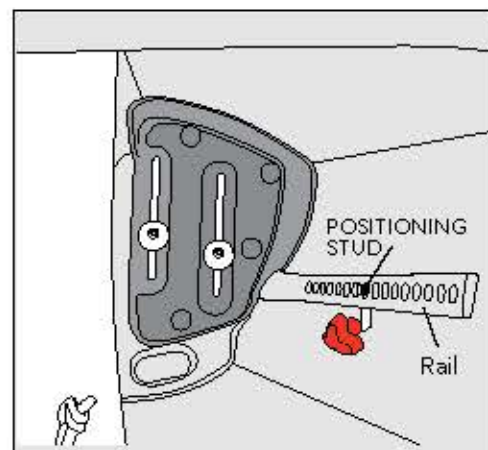
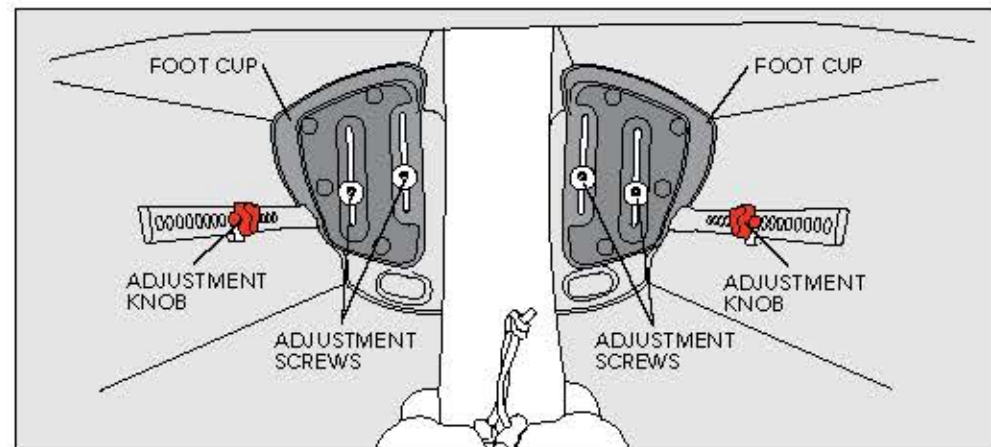

FOOT BRACE OUTFITTING

1. Position the foam wedge over the Velcro[®] pad on the foot brace. Note: Make sure the thick end of the wedge is seated against the hull surface of the boat.
2. Using the template and a cutting tool, trim the foam pads to fit over the foam wedge (optional). Visit dagger.com/services to download template.
3. Make sure the foam pads fit properly then reveal the adhesive strips and press into place.

PRO TIP

- Test fit all foam components with proper paddling shoes and gear prior to final placement!
- Use as much foam padding as possible to ensure comfort and protection for the feet and ankles during an impact.

FREESTYLE FOOT BRACE

1. Loosen strap and add/remove foam shims to achieve desired comfort.
2. Tighten strap, place in boat and check for comfort and fit.

PRO TIP - You can use sandpaper and/or a cutting tool to shape the contour of the foam mountain to fit the arch of your feet.

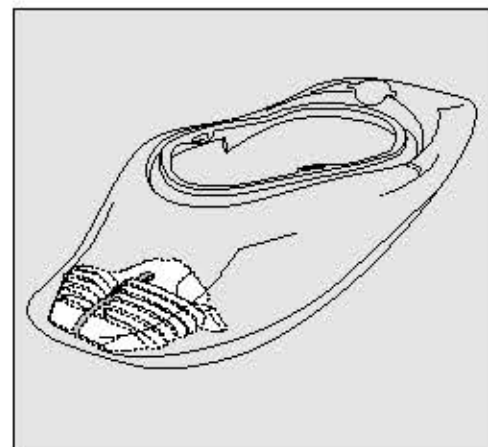
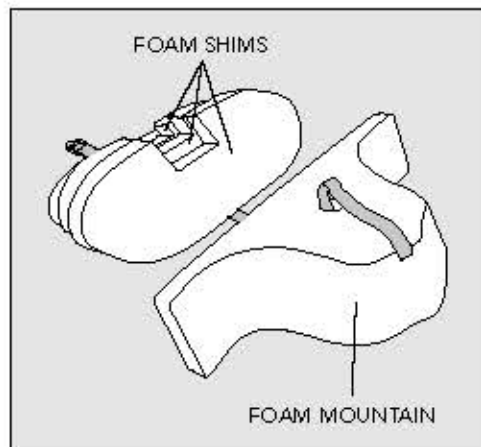

THIGH BRACE ADJUSTMENT

1. Climb into the cockpit and get comfortable.
2. Using a Phillips screwdriver, remove both thigh brace set screws.
3. Loosen, but DO NOT remove, the thigh brace adjustment screws.
4. Position both thigh braces comfortably against your thighs by sliding fore or aft.
5. Securely tighten all four adjustment screws.
6. Install and securely tighten both set screws.

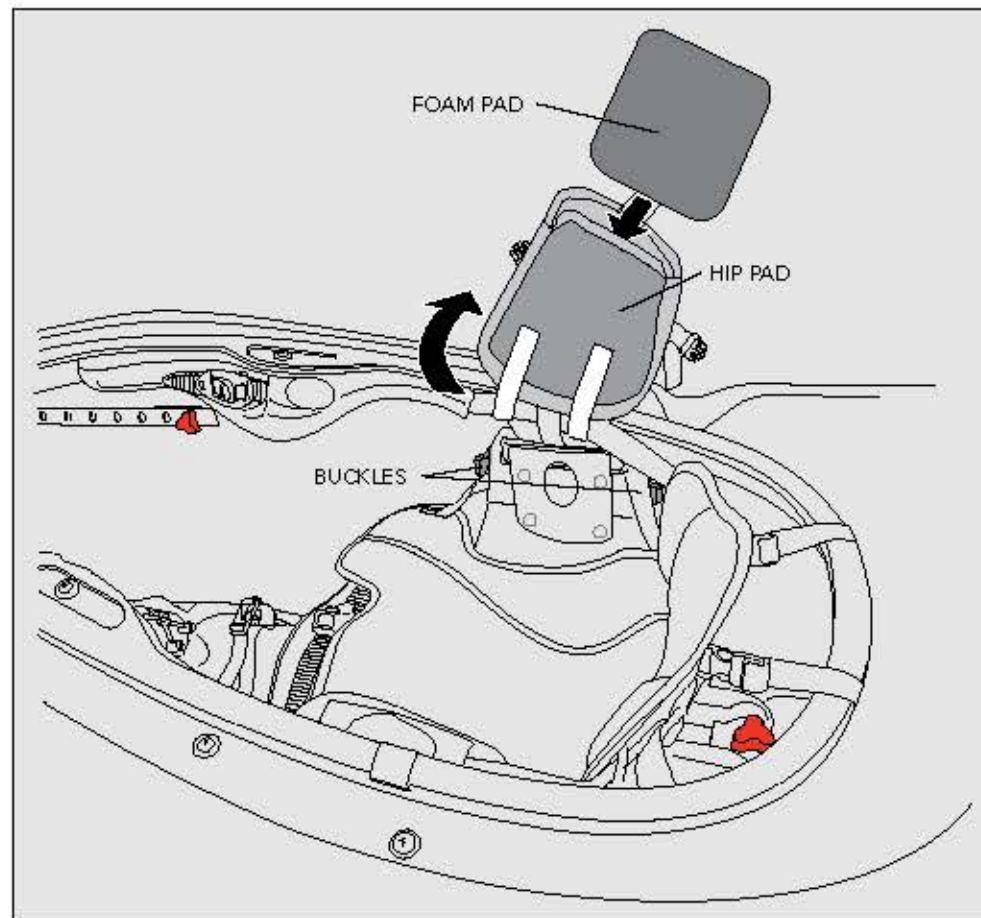
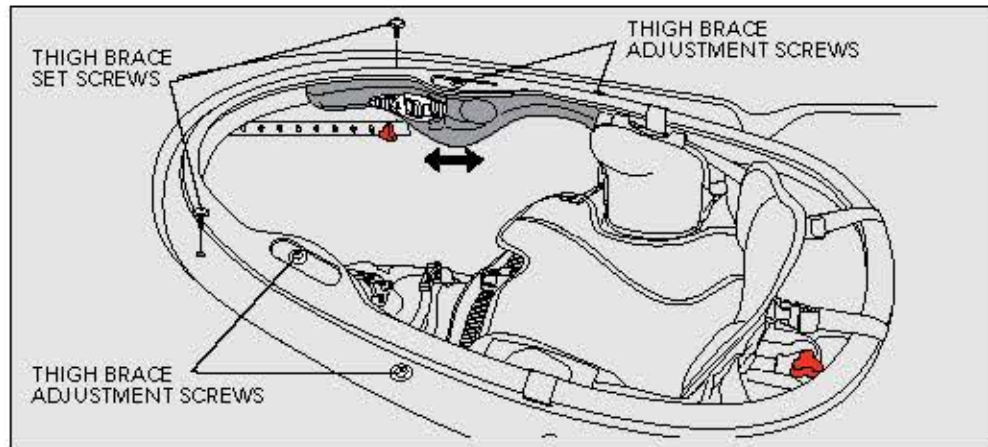

HIP PAD COMFORT ADJUSTMENT

1. Disconnect two buckles.
2. Swing hip pad upward.
3. Insert foam padding into the pocket on the back of the hip pad.
4. After you have inserted as much foam padding as desired, reseal and lower hip pad and Velcro® into desired position, FASTEN BOTH BUCKLES, and tighten the straps.
5. Stow the straps by wrapping them back behind the buckles and fastening to the Velcro® tabs.

PRO TIP

- Always test your adjustments on calm water!
- Use the wedge shaped shim, with the thick edge on top, to create a "hook" over the hip and thigh area. Avoid direct pressure of the hip pads to the hip joint to prevent fatigue or discomfort.

LEG LIFTER ADJUSTMENT

1. Climb into the cockpit and get comfortable.
2. Ratchet the leg lifter adjustment until the leg lifter is at desired height.
3. To loosen the adjuster, squeeze the release lever, as shown.

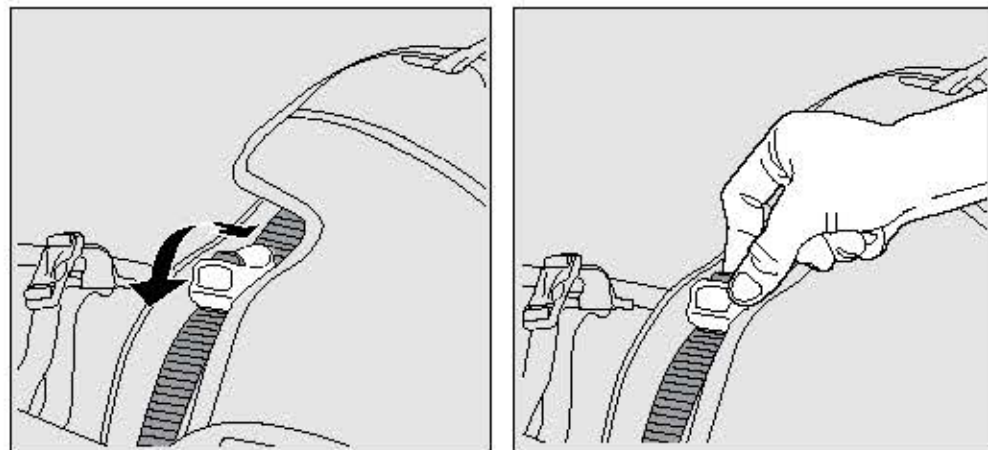

SEAT BOOSTER SHIM

1. Disconnect the retaining bands beneath the front corners of the seat pad.
2. Slip the seat foam shim beneath the seat pad. Reveal the adhesive strips to keep it in place (optional).
3. Re-connect the retaining bands beneath the front corners of the seat pad.

PRO TIP - Use the seat booster shim on waves to gain leverage over the boats carving rails. Use it in holes to provide more reach and improve rotation in overcoming the boats deck volume.

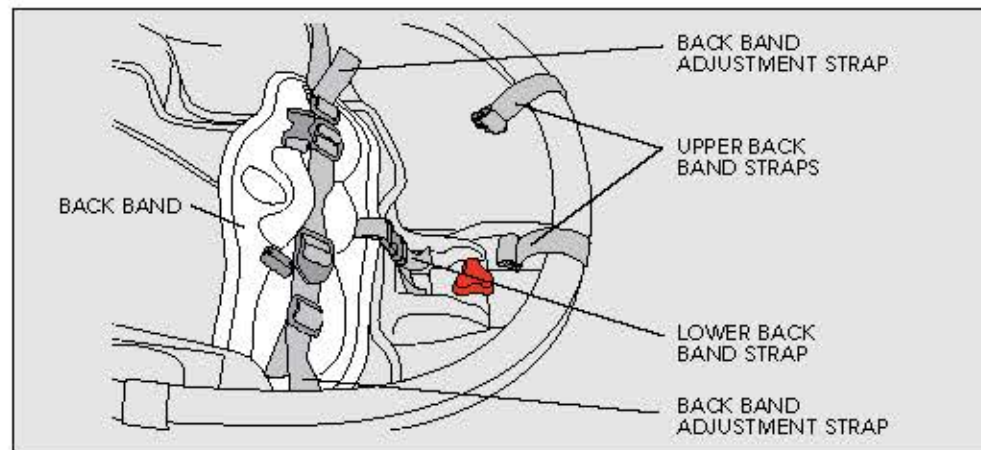
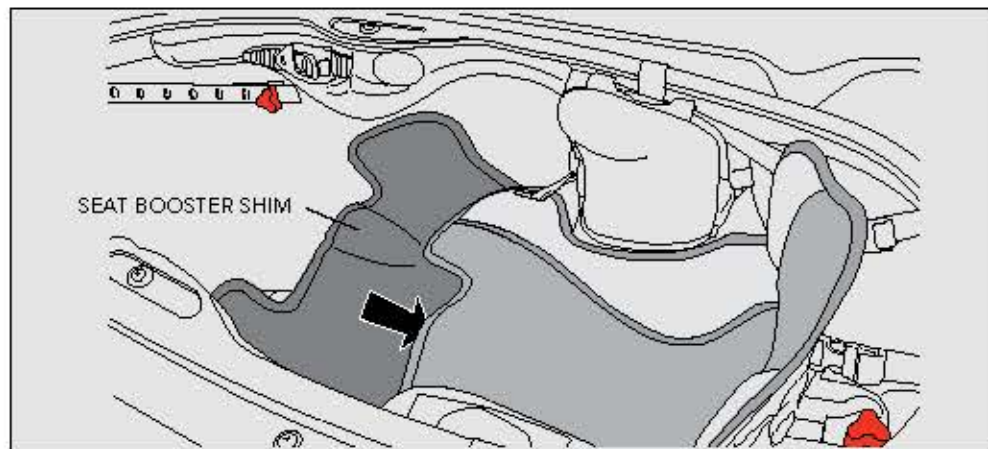

BACK BAND ADJUSTMENT

PRIMARY BACK BAND ADJUSTMENT

1. Disconnect both upper back band straps.
2. Pull the vertical lower back band strap until back band is positioned at the small of the back.
3. Adjust back band adjustment strap through buckles, as necessary.
4. Fasten both upper back band straps.

SECONDARY BACK BAND ADJUSTMENT

1. Ratchet both back band adjusters until back band is at desired firmness.
2. To loosen the adjuster, squeeze the release lever, as shown.

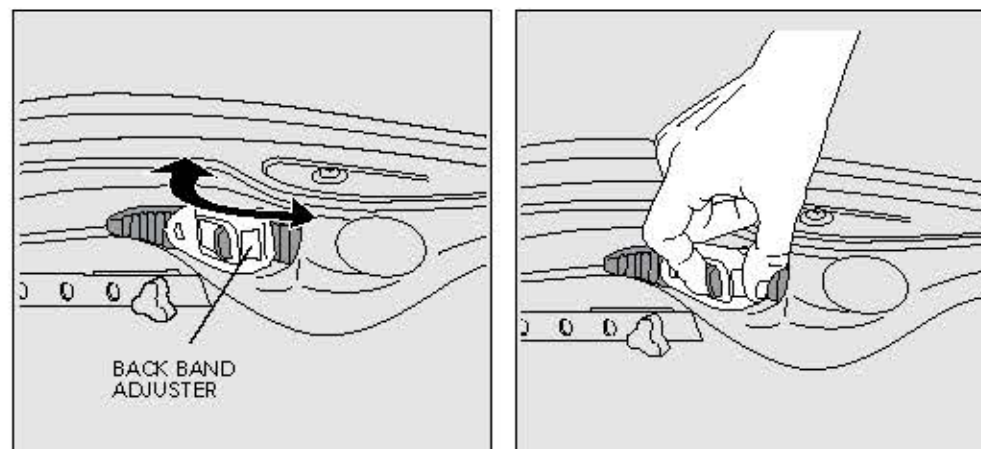

STORAGE AND GEAR ATTACHMENT POINTS

- Your Dagger Contour Ergo seat system has multiple gear attachment and storage points located across the system.
- A strap and buckle gear system is located at the bow position of the hull beam. Secure your gear in the storage well and buckle the straps together. Adjust the straps to desired fit. Additional tension can be created in the bow storage system by adjusting the cord lock and bungee at the front of the hull beam storage well.
- Multiple gear loop attachment points with quick clip access can be found throughout the system.
- The creek system includes a storage tray with bungee.
- Space under the leg lifter can be utilized for additional storage.

PRO TIP - Use the bow storage straps for water bottles, rescue throw bags, sponges, or small dry bags.

Confluence Outdoor
575 Mauldin Road, Suite 200
Greenville, SC 29607
www.dagger.com

